

EX1800

- Rated engine HP (gross)... 746 kW (1 000 HP)
- Operating weight..... EX1800-2
 - Loading shovel: 177 000 kg (390 000 lb)
 - Backhoe: 177 000 kg (390 000 lb)
- Loading shovel bucket PCSA heaped: 10.3 — 14.5 m³
(13.5 — 19.0 cu yd)
- Backhoe bucket..... PCSA heaped: 4.3 — 14.0 m³
(5.6 — 18.3 cu yd)
- CECE heaped: 3.8 — 12.5 m³

Specifications

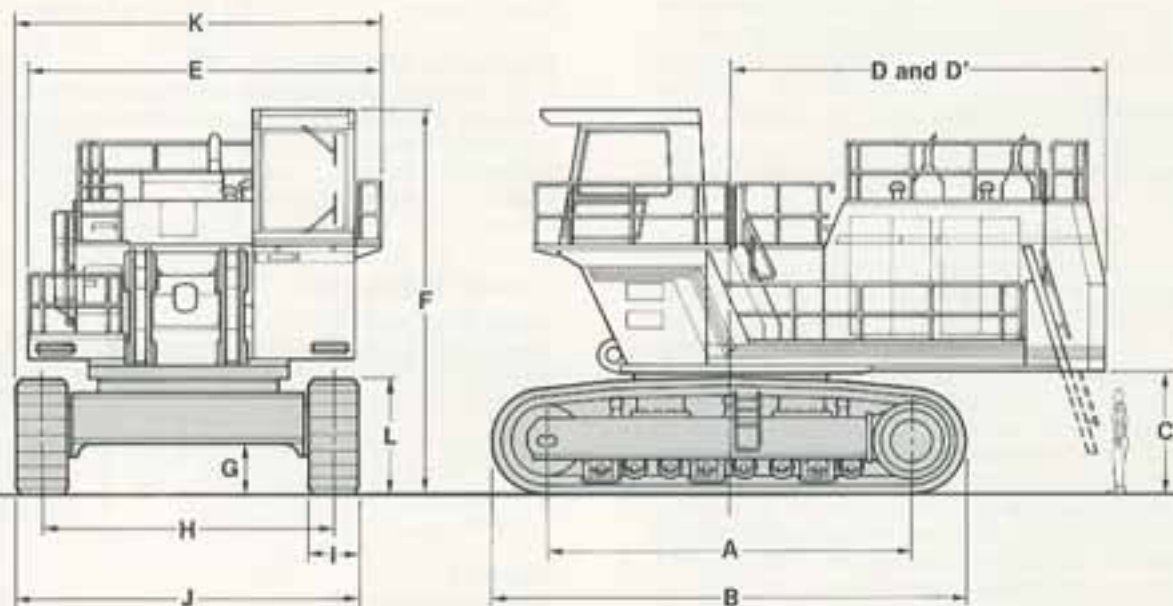

A	Distance between tumbler	5 780 mm (19' 0")	
B	Undercarriage length	7 480 mm (24' 6")	
C	Counterweight clearance	2 100 mm (6' 11")	
D	Rear-end swing radius	6 010 mm (19' 9")	
D'	Rear-end length	5 950 mm (19' 6")	
E	Overall width of superstructure	5 570 mm (18' 3")	
F	Overall height of cab (with headguard)	6 115 mm (20' 1")	
G	Min. ground clearance	810 mm (2' 8")	
H	Track gauge	4 600 mm (15' 1")	
I	Track shoe width	800 mm (31")	1 000 mm (39")
J	Undercarriage width	5 400 mm (17' 9")	5 600 mm (18' 4")
K	Overall width	5 770 mm (18' 11")	
L	Track height	1 860 mm (6' 1")	

TECHNICAL DATA

ENGINE

Model	Cummins KTA19-C525
Type	Water-cooled, 4-cycle, 6-cylinder in line, turbo-charged and after-cooled, direct injection chamber-type diesel engine
Rated flywheel horsepower (DIN 6271, net)	2 x 321 kW (2 x 436 PS) at 1 800 min ⁻¹ (1 800 rpm)
Rated flywheel horsepower (SAE J1349, net)	2 x 321 kW (2 x 430 HP) at 1 800 min ⁻¹ (1 800 rpm)
Maximum flywheel horsepower (SAE J1349, gross)	2 x 392 kW (2 x 525 HP) at 2 100 min ⁻¹ (2 100 rpm) 2 x 373 kW (2 x 500 HP) at 1 800 min ⁻¹ (1 800 rpm)
Maximum torque	2 x 2 060 N·m (210 kgf·m, 1 520 ft·lbf) at 1 500 min ⁻¹ (1 500 rpm)
Piston displacement	2 x 18.9 l (2 x 1 150 cu in)
Bore and stroke	159 mm x 159 mm (6.3" x 6.3")
Starting system	24 V electric motor
Batteries	4 x 12 V, 4 x 160 AH
Preheating method	Ether aided

Electric motor-driven type is available on order.

HYDRAULIC SYSTEM

Hitachi's ETS (Electronic Total control System) can achieve maximum job efficiency and reduce fuel consumption/noise.

- E-P Control (Computer-aided Engine-Pump Control system) Main pumps regulated by electronic engine-speed sensing control system. Optimum operation mode selectable among 4 power modes depending on type of job.
- OHS (Optimum Hydraulic System) 4 main pumps, 2 independent swing pumps and travel flow-in valve system enable both independent and combined operations of all functions.
- FPS (Fuel-saving Pump System) minimizes energy loss with superior performance in fine control.
- Auto-idling system for saving fuel and reducing noise.
- RMS (Relief-oil Minimizing System) reduces energy losses with minimum oil flow.
- Forced-lubrication and forced-cooling pump drive system.
- TIG (Tungsten Inert Gas) welding pipings.

Main pumps	4 variable-displacement, bent-axis piston pumps for front attachment and travel
Pressure setting	29.4 MPa (300 kgf/cm ² , 4 270 psi)
Max. oil flow	4 x 500 l/min (4 x 132.1 US gpm, 4 x 110.0 Imp gpm)
Swing pumps	2 variable-displacement, axis piston pumps for swinging
Pressure setting	29.4 MPa (300 kgf/cm ² , 4 270 psi)
Max. oil flow	2 x 344 l/min (2 x 90.9 US gpm, 2 x 75.7 Imp gpm)
Pilot pumps	2 gear pumps
Pressure setting	4.3 MPa (44 kgf/cm ² , 625 psi)
Max. oil flow	2 x 35 l/min (2 x 9.25 US gpm, 2 x 7.70 Imp gpm)

Relief Valve Settings

Boom/arm/bucket circuit	29.4 MPa (300 kgf/cm ² , 4 270 psi)
Travel circuit	29.4 MPa (300 kgf/cm ² , 4 270 psi)
Swing circuit	29.4 MPa (300 kgf/cm ² , 4 270 psi)
Pilot circuit	4.3 MPa (44 kgf/cm ² , 625 psi)

Hydraulic Cylinders

High-strength piston rods and tubes adopted. Cylinder cushion mechanisms are provided for boom, arm and bucket cylinders. Boom cylinder ends use self-alignment spherical bearings to avoid bending force. Bucket cylinder of loading shovel is provided with protector.

Cylinder Dimensions

Loading shovel

	Quan.	Bore	Rod diameter
Boom	2	280 mm (11.0")	200 mm (7.9")
Arm	1	240 mm (9.4")	180 mm (7.1")
Bucket	2	225 mm (8.9")	170 mm (6.7")
Dump	2	190 mm (7.5")	110 mm (4.3")
Level	1	280 mm (11.0")	200 mm (7.9")

Backhoe

	Quan.	Bore	Rod diameter
Boom	2	280 mm (11.0")	200 mm (7.9")
Arm	2	250 mm (9.8")	170 mm (6.7")
Bucket	2	200 mm (7.9")	150 mm (5.9")

Hydraulic Filters

All hydraulic circuits have high-quality hydraulic filters for protection against oil contamination and longer life of hydraulic components. 5 full-flow filters of 10 μm are built in return circuit, 4 high-pressure strainer of 100 μm, 2 drain filters of 10 μm in swing and travel motor drain lines, 3 μm by-pass filter in oil cooler by-pass line, 10 μm pilot filter in pilot control circuit, and suction filters in suction line. These filters are centralized in arrangement for facilitating maintenance.

CONTROLS

2 Implement Levers

Remote-controlled joystick hydraulic servo system. Right lever is for boom and bucket control, left lever for swing and arm control. For loading shovel, 2 pedals provided for opening/closing the bottom dump bucket, Auto-Leveling Crowd Mechanism featuring simplified level crowding is provided as standard.

2 Travel Levers with Pedals

Remote-controlled hydraulic servo system. Independent drive at each track allows counterrotation of tracks.

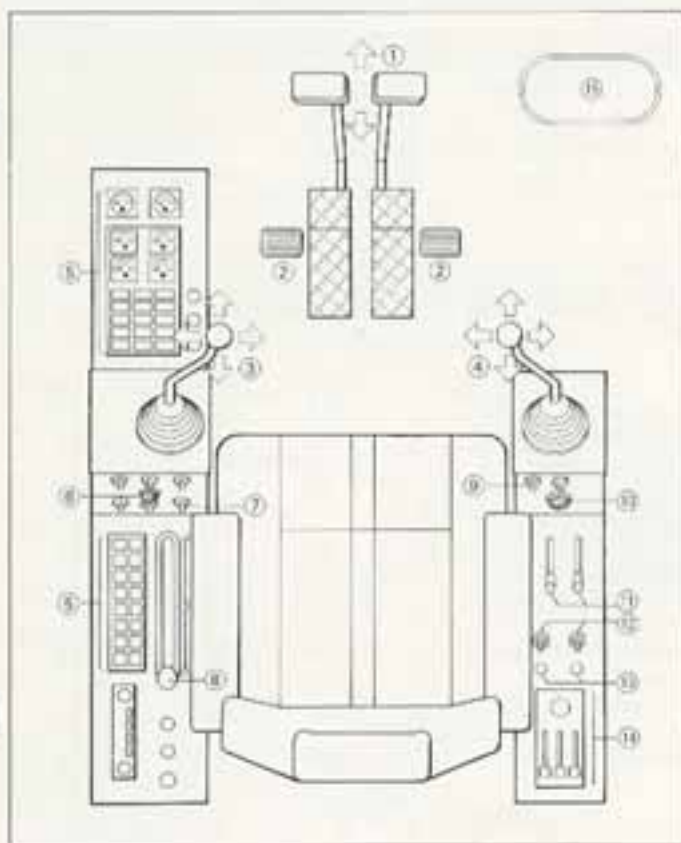

- ① Travel levers with pedals
- ② Bucket open/close pedals (Loading shovel)
- ③ Swing/Arm control lever
- ④ Boom/Bucket control lever
- ⑤ Monitor panel
- ⑥ Power mode switch
- ⑦ Auto-idling switch
- ⑧ Parking/Traveling speed selector lever
- ⑨ Level luffing switch
(circular arc retracting; Loading shovel)
- ⑩ Emergency engine stop switch
- ⑪ Fuel (throttle) lever
- ⑫ Engine starter switch
- ⑬ Ether switch (in cold conditions)
- ⑭ Air conditioner switch (option)
- ⑮ Floor glass

SUPERSTRUCTURE

Revolving Frame

A deep, full-reinforced box section. Heavy-gauge steel plates used for ruggedness.

Deck Machinery

Maintenance accessibility is the major feature in the layout of deck machinery. Walkways provide easy access to engines, hydraulic and electrical components. ISO-met stairs and handrails. Catwalks and stairs are provided with non-slip gratings.

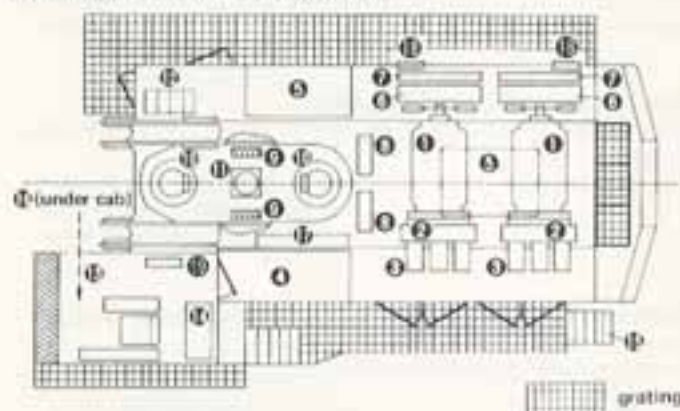

- ① Engine x 2
- ② Pump drive unit x 2
- ③ Hydraulic pump x 6
- ④ Hydraulic oil tank
- ⑤ Fuel tank x 2
- ⑥ Engine radiator x 2
- ⑦ Oil cooler x 2
- ⑧ Main control valve x 2
- ⑨ Swing control valve x 2
- ⑩ Swing device x 2
- ⑪ Center Joint
- ⑫ Batteries
- ⑬ Cab
- ⑭ Air-conditioning unit
- ⑮ Ladder
- ⑯ Tool box (under cab)
- ⑰ Filters
- ⑱ Pump drive transmission oil cooler
- ⑲ Cooling unit

Swing Mechanism

2 high-torque, axial-piston motors with two-stage planetary gear run in oil. Diametrically-opposed, well-balanced arrangement of 2 swing devices. Swing circle with dirt seals is a heavy-duty, single-row, sheer-type ball bearing. Induction-hardened internal swing circle gear and pinion immersed in lubricant. Smooth hydraulic swing brake system with lock valve.

Swing speed..... 4.8 min⁻¹ (4.8 rpm)

Operator's Cab

Steel construction with integrated, falling-object-protective structure meeting SAE FOPS. Independent, pressurized, 1 600 mm (5'3") wide, 2 150 mm (7'1") high, roomy 6.1 m³ (8 cu yd) cab with tinted glass windows features all-round visibility.

Spring-suspension-type, fully-adjustable seat. Instrument and control panel is in easy range of the operator. Rubber-mounting and sound-proofing structure to reduce noise level and vibration. Air conditioner is optional.

Noise level..... 70 dB (A) in the cab; on max. engine speed under no-load condition

Eye level height..... 5 260 mm (17'3")

TECHNICAL DATA



UNDERCARRIAGE

Tracks

Tractor-type undercarriage. Dual-flanged-type bolt linkage for side frame and X-form center frame assures durability. Heavy-duty track frame of all-welded, stress-relieved structure. Top-grade materials used for toughness. Lifetime-lubricated induction-hardened track rollers, idlers and sprockets with floating seals. Track shoes of durable box-type cast steel with triple grousers. Durable strut-reinforced track links with track guards. Hydraulic track adjuster provided with N₂ gas accumulator with relief valve. Track adjuster provided with protection device against abnormal tension. Travel motion alarm device.

Tractor-type Undercarriage

Triple grouser track shoes of induction-hardened cast steel

Shoe width 800 mm (31") Standard
1 000 mm (39") optional for
Backhoe attachment only

Numbers of Rollers and Shoes on Each Side

Upper rollers 3
Lower rollers 8
Track shoes 49

Traction Device

Each track driven by a high-torque, axial piston motor, allowing counterrotation of tracks. 2-stage planetary gear plus spur gears reduction device. Parking brake of spring-set/hydraulic-released disc type. This parking brake is manually releasable.

Travel speeds High: 0 to 2.8 km/h (1.7 mph)
Low: 0 to 2.1 km/h (1.3 mph)

Maximum traction force 941.5 kN
(96 000 kgf, 212 000 lbf)

Gradeability 30° (60%) max.



WEIGHTS AND GROUND PRESSURE

Loading Shovel

Equipped with 10.3 m³ (13.5 cu yd; PCSA heaped) bottom dump bucket

Shoe type	Shoe width	Operating weight	Ground pressure
Triple grousers	800 mm (31")	177 000 kg (390 000 lb)	170.6 kPa (1.74 kgf/cm ² , 24.7 psi)

Backhoe

Equipped with 8.70 m (28'7") boom, 4.00 m (13'1") arm, and 9.5 m³ (12.4 cu yd; PCSA heaped) bucket

Shoe type	Shoe width	Operating weight	Ground pressure
Triple grousers	800 mm (31")	177 000 kg (390 000 lb)	170.6 kPa (1.74 kgf/cm ² , 24.7 psi)
	1 000 mm (39")	179 000 kg (395 000 lb)	138.3 kPa (1.41 kgf/cm ² , 20.1 psi)



SERVICE REFILL CAPACITIES

	liters	US gal	Imp gal
Fuel tank.....	2 350	621	517
Engine coolant.....	120	31.7	26.4
(per engine)			
Engine oil.....	50	13.2	11.0
(per engine)			
Pump drive.....	21	5.5	4.6
(per engine)			
Swing drive device.....	2 x 67	2 x 17.7	2 x 14.7
(2 units)			
Travel drive device.....	90	23.8	19.8
(each side)			
Hydraulic system.....	2 140	565	471
(including hydraulic tank)			
Hydraulic tank.....	955	252	210



LOADING SHOVEL ATTACHMENTS

Boom and arm are of all-welded, low-stress, high-tensile strength steel full-box section design. Efficient, automatic level crowding achieved by one-lever control because parallel link mechanism keeps the bucket digging angle constant, and level cylinder circuit maintains the bucket height constant. (Auto-Leveling Crowd Mechanism)

- 110 kgf/mm² (156 000 psi) tensile strength steel bucket bottom plate
- Both circular arc retracting and horizontal retracting are possible (loading shovel)
- Dual-support-type boom/arm/bucket pin linkage
- Pin seals (in all portions) plus O-ring at arm top



WORKING RANGES

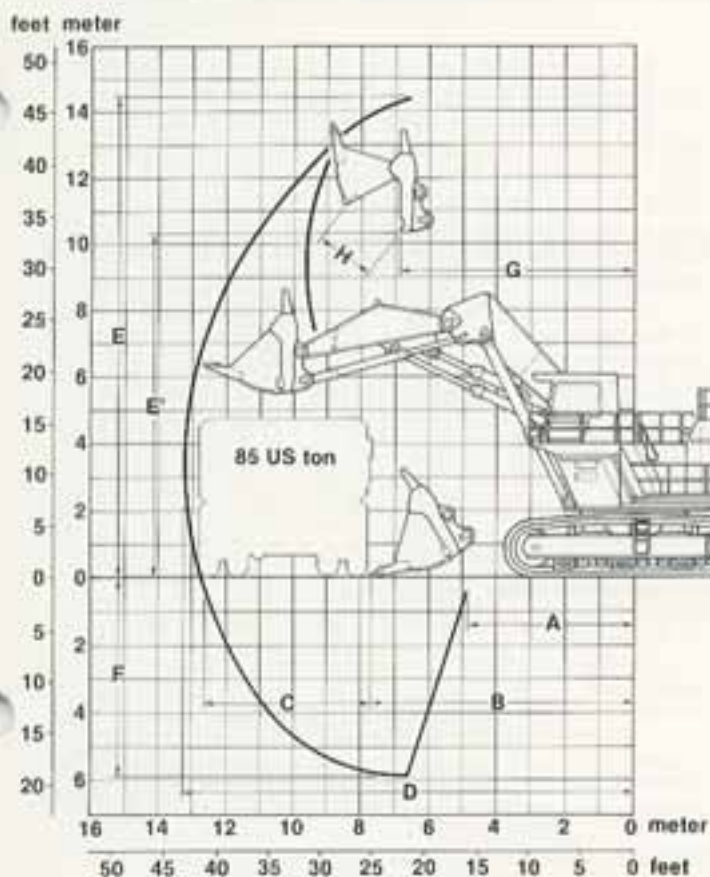

A	Min. digging distance	4 990 mm (16' 4")
B	Min. level crowding distance	7 730 mm (25' 4")
C	Level crowding distance	4 940 mm (16' 2")
D	Max. digging reach	13 400 mm (44' 0")
E	Max. cutting height	14 550 mm (47' 9")
E'	Max. dumping height	10 400 mm (34' 1")
F	Max. digging depth	5 920 mm (19' 5")
G	Working radius at max. dumping height	6 890 mm (22' 7")
H	Max. bucket opening width	2 100 mm (6' 11")
Crowding force	10.3 m ³ (13.5 cu yd)	716 kN (73 000 kgf, 161 000 lbf)
	14.5 m ³ (19.0 cu yd)	667 kN (68 000 kgf, 150 000 lbf)
Breakout force	10.3 m ³ (13.5 cu yd)	667 kN (68 000 kgf, 150 000 lbf)
	14.5 m ³ (19.0 cu yd)	628 kN (64 000 kgf, 141 000 lbf)

Data in are those of the Coal bottom dump type bucket.

Buckets (PCSA heaped)

Capacity	Width	No. of teeth	Weight	Type
10.3 m ³ (13.5 cu yd)	3 440 mm (11' 3")	6	14 100 kg (31 100 lb)	Bottom dump type general purpose bucket
14.5 m ³ (19.0 cu yd)	4 340 mm (14' 3")	6	15 100 kg (33 300 lb)	Bottom dump type coal handling bucket

TECHNICAL DATA



BACKHOE ATTACHMENTS

Boom and arm are of all-welded, low-stress, full-box section design. Bucket of all-welded, high-strength steel structure.



WORKING RANGES

feet meter

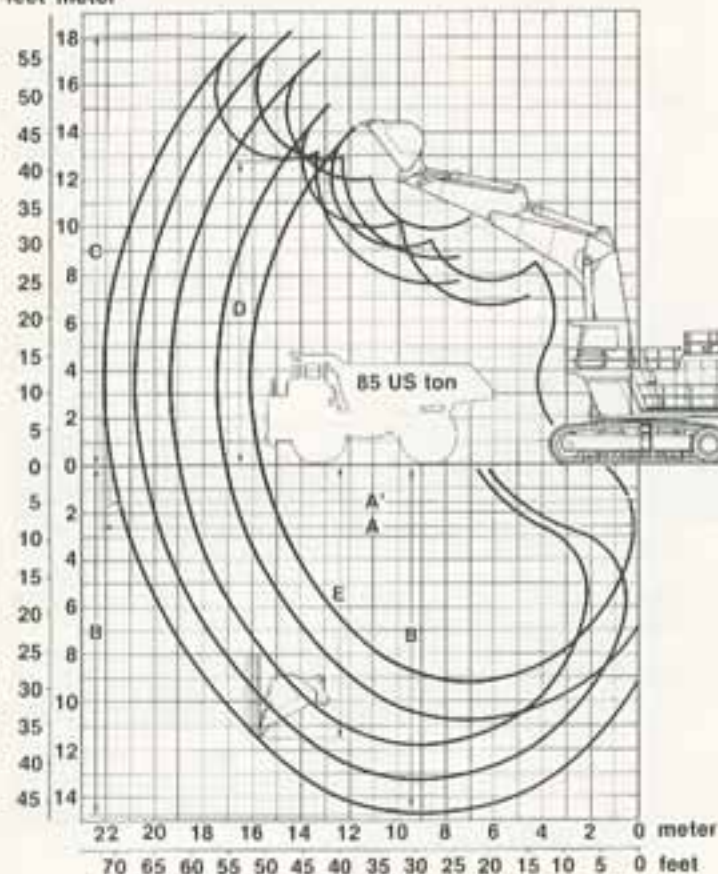

Unit: mm (ft in)

Boom length	8.70 m (28'7")		11.80 m (38'9")		
Arm length	4.00 m (13'1")	5.50 m (18'1")	4.00 m (13'1")	5.50 m (18'1")	7.00 m (23'0")
A Max. digging reach	16 070 (52'9")	17 500 (57'5")	19 300 (63'7")	20 800 (68'5")	22 100 (72'6")
A' Max. digging reach (on ground)	15 640 (51'4")	17 100 (56'1")	19 030 (62'5")	20 530 (67'4")	21 700 (71'6")
B Max. digging depth	9 260 (30'5")	10 760 (35'4")	11 820 (38'9")	13 320 (43'8")	14 770 (48'5")
B' Max. digging depth (at level)	9 150 (30'0")	10 670 (35'0")	11 710 (38'5")	13 230 (43'5")	14 680 (48'2")
C Max. cutting height	14 450 (47'5")	15 190 (49'10")	17 340 (56'11")	18 170 (59'7")	18 020 (59'1")
D Max. dumping height	9 160 (30'1")	9 780 (32'1")	11 790 (38'8")	12 620 (41'5")	12 710 (41'8")
E Max. vertical wall	6 620 (21'9")	7 960 (26'1")	10 100 (33'2")	11 430 (37'6")	11 480 (37'8")
Digging force (arm cylinder)	559 (125 000)	455 (102 300)	559 (126 000)	455 (102 300)	392 (88 200)
Digging force (bucket cylinder)	589 (132 000)	589 (132 000)	589 (132 800)	589 (132 000)	500 (112 400)

Buckets

Capacity		Width		No. of teeth	Weight	Recommendation				
PCSA heaped	CECE heaped	Without side cutters	With side cutters			8.70 m (28'7") boom		11.80 m (38'9") boom		
						4.00 m (13'1") arm	5.50 m (18'1") arm	4.00 m (13'1") arm	5.50 m (18'1") arm	7.00 m (23'0") arm
4.3 m ³ (5.6 cu yd)	3.8 m ³ (5.0 cu yd)	1 400 mm (4'7")	—	5	4 370 kg (9 600 lb)					⊙
5.0 m ³ (6.5 cu yd)	4.5 m ³ (5.9 cu yd)	1 650 mm (5'5")	—	5	5 180 kg (11 400 lb)				⊙	
5.9 m ³ (7.7 cu yd)	5.3 m ³ (6.9 cu yd)	1 950 mm (6'5")	—	5	6 100 kg (13 400 lb)			⊙		
7.8 m ³ (10.2 cu yd)	7.0 m ³ (9.2 cu yd)	2 570 mm (8'5")	—	5	8 050 kg (17 700 lb)		⊙			
9.5 m ³ (12.4 cu yd)	8.4 m ³ (11.0 cu yd)	2 710 mm (8'11")	—	5	8 390 kg (18 500 lb)	⊙				
14.0 m ³ (18.3 cu yd)	12.5 m ³ (16.3 cu yd)	3 300 mm (10'10")	—	8	9 700 kg (21 400 lb)	○				

⊙ General purpose for materials with density of 2 000 kg/m³ (3 370 lb/cu yd) or less.
○ Suitable for materials with density of 1 100 kg/m³ (1 850 lb/cu yd) or less.



STANDARD EQUIPMENT

Standard equipment may vary by country, so please consult your Hitachi dealer for details.

Cab

Reinforced/tinted-glass (bronze color) side windows. Wide-shield, parallel-link-type intermittent wiper. Front window washer. Sliding-type window on left window. Spring-suspension cushion-type, fully-adjustable seat with armrests and headrest. Digital clock. AM/FM radio. Defroster. Rearview mirror. Electric double horn. Cigarette lighter and ashtray. Parcel pocket.

Monitoring Alarm System

- Meters
Hourmeter, Engine oil pressure, Engine coolant temperature, Air pressure, Fuel meter
- Warning lamps (Red)
Engine oil pressure, Engine overheat, Hydraulic oil temperature, Pump drive oil pressure, Hydraulic oil level, Pump Contamination, Minimum fuel level (150 l, 40 US gal, 33 Imp gal), Alternator charge, Hydraulic filter clog, Pilot filter clog, Air cleaner clog, Engine room emergency, Ladder, Auto lubrication (option), Side monitor warning, Engine controller
- Pilot lamps (Green)
Engine oil level, Pump drive oil level, Engine coolant level, Swing drive oil level, Hydraulic oil level
- Alarm buzzers
Engine oil pressure, Engine overheat, Hydraulic oil temperature, Pump drive oil pressure, Engine room emergency

Lights

6 working lights, 1 access light, 1 cab light

Superstructure

Lockable machine covers. Overall undercover, 24 900 kg (54 900 lb) counterweight. Lockable storage compartment. 2 lamps in engine room and storage compartment (under the cab). Pneumatic grease gun with hose reel. Hold-in-type ladder with spring-type balancer. Cartridge-type filters for engine oil, engine oil by-pass, fuel and coolant. Control valves with main relief valves and overload relief valves. Accumulator for pilot circuit.

Undercarriage

Parking brake is spring-set/hydraulic-released disc type. Hydraulic track adjuster provided with N₂ gas accumulator with relief valve. Travel motion alarm device. Lifetime-lubricated rollers, idler, and sprockets. Travel motor cover.

Miscellaneous

Standard tool kit. Grated catwalks and stairs. Handrails. Heavy-duty-type air cleaner with evacuator valve. Radiator reserve tank.



OPTIONAL EQUIPMENT

Optional equipment may vary by country, so please consult your Hitachi dealer for details.

- Auto-lubrication system (Lincoln) for front-attachment pins, swing bearing, and center joint
- Air conditioner with defroster, damper, and filter
- Cooling unit
- Seat belt

TRANSPORTATION

- Easily assembled owing to local assembling system requiring no welding.
- Overall width of below 3 500 mm (11'6") during transportation.

SUPERSTRUCTURE

Unit: mm (ft in)

Cab; 1 780 kg (3 920 lb) Cab under cover; 640 kg (1 410 lb) Radiator cover; 76 kg (168 lb) Muffler cover; 25 kg (55 lb) x 2

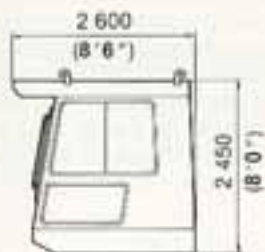

Width; 1 600 (5'3")

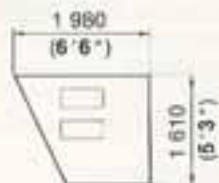

Width; 1 600 (5'3")

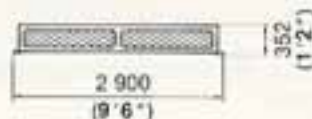

Height; 1 520 (5'0")



Width; 1 300 (4'3")

Muffler; 44 kg (97 lb) x 2

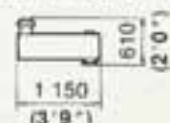

Width; 370 (1'3")

Basic machine; 36 000 kg (79 400 lb)

Counterweight; 24 900 kg (54 900 lb)

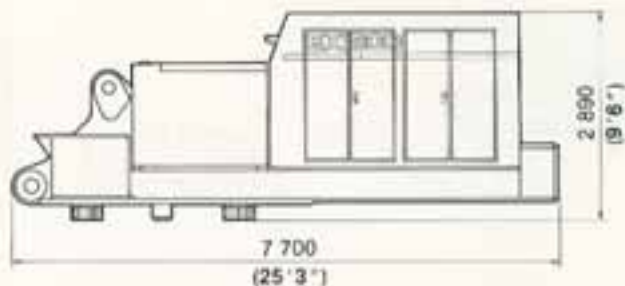

Width; 3 500 (11'6")



Width; 935 (3'1")

Cat walk; 25 kg (55 lb)

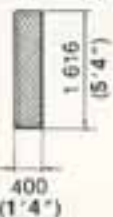

Height; 160 (0'6")

Cat walk; 309 kg (681 lb)

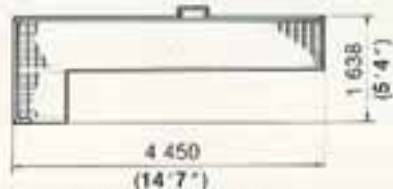

Height; 1 385 (4'7")

Cat walk; 173 kg (381 lb)

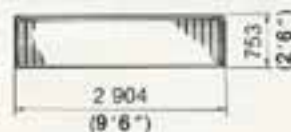

Height; 1 385 (4'7")

Cat walk; 79 kg (174 lb)



Height; 1 207 (4'0")

Cat walk; 302 kg (666 lb)



Height; 1 835 (6'0")

Cover; 12 kg (26 lb) Cover; 27 kg (60 lb)

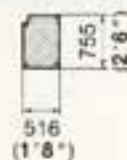

Height; 1 140 (3'9")



Height; 1 140 (3'9")

Handrail; 36 kg (79 lb)

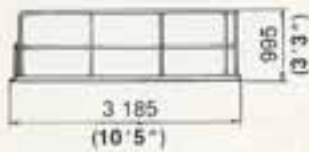

Width; 300 (1'0")

Handrail; 13 kg (29 lb)

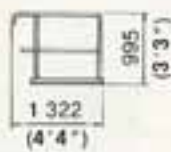

Width; 70 (0'3")

Handrail; 19 kg (42 lb)

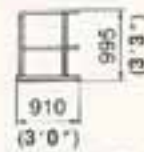

Width; 790 (2'7")

Handrail; 18 kg (40 lb)

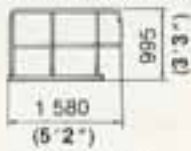

Width; 70 (0'3")

Handrail; 36 kg (79 lb)

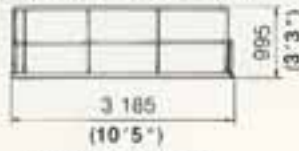

Width; 300 (1'0")

Handrail; 44 kg (97 lb)



Width; 660 (2'2")

Ladder; 70 kg (154 lb)



Width; 490 (1'7")

Ladder; 13 kg (29 lb)



Width; 235 (0'9")

Ladder; 240 kg (529 lb)

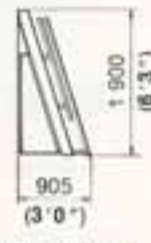

Width; 700 (2'4")

UNDERCARRIAGE

Track center frame assembly; 17 000 kg (37 500 lb)

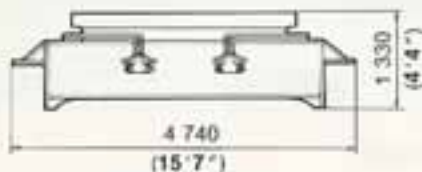

Width; 3 490 (11'5")

Track side frame assembly; 21 900 kg (48 300 lb) x 2



Width; 1 620 (5'4")

Motor covers;

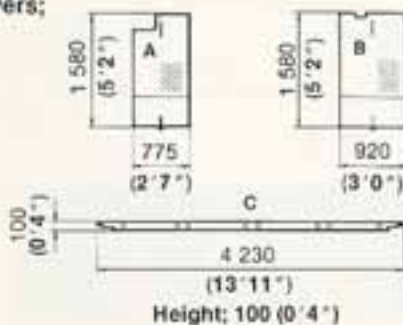

Height; 100 (0'4")

- A: Center cover..... 32 kg (71 lb) x 2
- B: Side cover..... 44 kg (97 lb) x 2
- C: Stay..... 78 kg (172 lb)

Ladder; 15 kg (33 lb) x 2

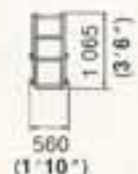

Height; 142 (0'6")

TRANSPORTATION

LOADING SHOVEL ATTACHMENT

Bucket

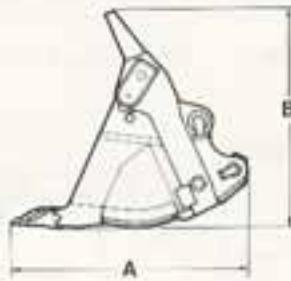

Boom & arm assembly; 24 800 kg (54 700 lb)

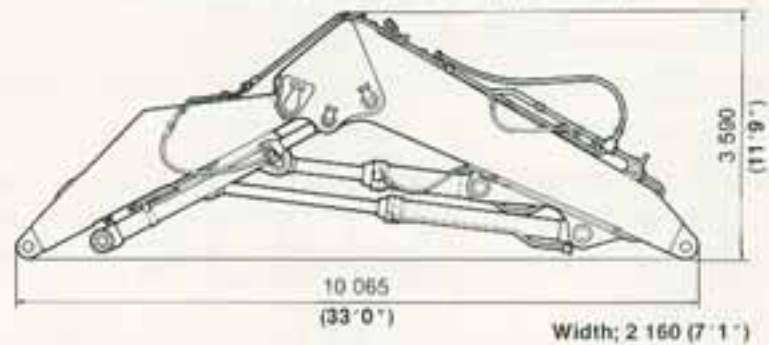

Bucket Capacity	A	B	Width	Weight
10.3 m ³ (13.5 cu yd)	3 240 mm (10'8")	3 070 mm (10'1")	3 440 mm (11'3")	14 500 kg (32 000 lb)
14.5 m ³ (19.0 cu yd)	3 510 mm (11'6")	3 150 mm (10'4")	4 340 mm (14'3")	15 500 kg (34 200 lb)

Boom cylinders; 2 275 kg (5 020 lb) x 2

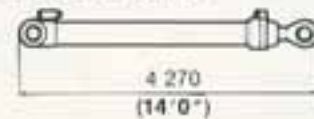

BACKHOE ATTACHMENT

Boom cylinders; 2 275 kg (5 020 lb) x 2

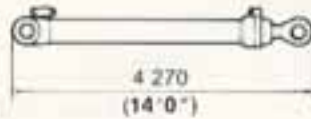

Bucket

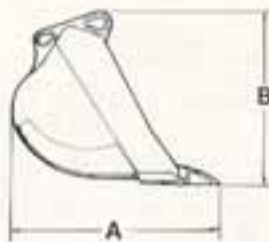

Boom assembly

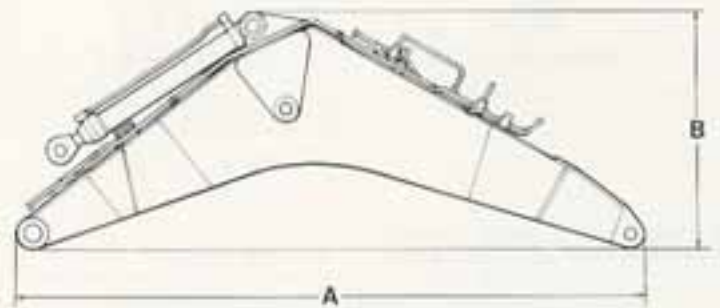

Boom length	A	B	Width	Weight
8.70 m (28'1")	9 120 mm (29'11")	3 500 mm (11'6")	1 785 mm (5'10")	18 610 kg (41 000 lb)
11.80 m (38'9")	12 220 mm (40'1")	3 700 mm (12'2")	2 050 mm (6'9")	22 700 kg (50 000 lb)

Bucket capacity		A	B	Width	Weight (with bucket pins)
PCSA heaped	CECE heaped				
5.0 m ³ (6.5 cu yd)	4.5 m ³ (5.9 cu yd)	2 750 mm (9'0")	2 610 mm (8'7")	1 650 mm (5'5")	4 370 kg (9 600 lb)
5.9 m ³ (7.7 cu yd)	5.3 m ³ (6.9 cu yd)	2 850 mm (9'3")	2 610 mm (8'7")	1 950 mm (6'5")	6 100 kg (13 400 lb)
7.8 m ³ (10.2 cu yd)	7.0 m ³ (9.2 cu yd)	2 910 mm (9'7")	2 610 mm (8'7")	2 570 mm (8'5")	8 050 kg (17 700 lb)
9.5 m ³ (12.4 cu yd)	8.4 m ³ (11.0 cu yd)	2 980 mm (9'9")	2 610 mm (8'7")	2 710 mm (8'11")	8 390 kg (18 500 lb)
14.0 m ³ (18.3 cu yd)	12.5 m ³ (16.3 cu yd)	3 100 mm (10'2")	2 610 mm (8'7")	3 300 mm (10'10")	9 700 kg (21 400 lb)

Arm assembly

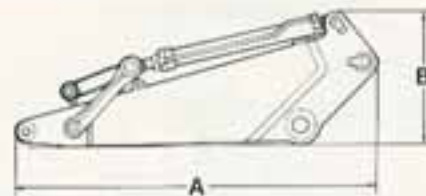

Arm length	A	B	Width	Weight
4.00 m (13'1")	5 280 mm (17'4")	1 945 mm (6'5")	1 720 mm (5'8")	9 990 kg (22 000 lb)
5.50 m (18'1")	6 780 mm (22'3")	1 700 mm (5'7")	1 720 mm (5'8")	11 500 kg (25 400 lb)

LIFTING CAPACITIES

ENGLISH MEASURE

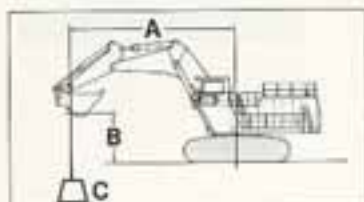

A: Load radius
B: Load point height
C: Lifting capacity

Rating over side or 360 degrees Rating over front

Unit: 1,000 lb

Conditions	Load point height ft	Load radius																At max. reach		
		25 ft		30 ft		35 ft		40 ft		45 ft		50 ft		55 ft		60 ft		ft	in	
Boom 28'7" Arm 13'1" Bucket PCSA: 12.4 cu yd Shoes 31"	30							*41.0	*41.0									*21.4	*21.4	48'5"
	25					*51.9	*51.9	*49.4	*49.4									*21.3	*21.3	49'11"
	20			*64.1	*64.1	*56.2	*56.2	*51.3	*51.3									*21.7	*21.7	50'9"
	15	*93.2	*93.2	*73.2	*73.2	*61.8	*61.8	*54.3	*54.3	*39.8	*39.8							*22.5	*22.5	51'1"
	10			*82.0	*82.0	*67.1	*67.1	53.3	*57.6	41.7	*49.1							*23.8	*23.8	50'7"
	5			84.3	*88.8	85.1	*71.7	51.1	*60.5	40.5	*50.3							*25.8	*25.8	49'7"
	0 (ground)	110.2	*119.4	81.4	*92.6	82.7	*74.7	49.5	*62.3									*28.5	*28.5	47'10"
	-5	109.1	*117.8	79.7	*93.1	81.3	*75.4	48.8	*62.1									*32.3	*32.3	45'4"
	-10	109.3	*112.2	79.4	*90.1	81.0	*73.0	48.7	*58.8									*27.1	*27.1	41'11"
	-15	*102.0	*102.0	80.3	*82.6	81.9	*65.8													
-20	*85.2	*85.2	*67.8	*67.8																
Boom 28'7" Arm 18'1" Bucket PCSA: 16.2 cu yd Shoes 31"	30									*26.7	*26.7							*13.4	*13.4	53'5"
	25							*41.4	*41.4	*35.3	*35.3							*13.4	*13.4	54'9"
	20							*44.4	*44.4	*42.1	*42.1							*13.7	*13.7	55'6"
	15					*54.1	*54.1	*48.2	*48.2	*44.3	*44.3	*21.1	*21.1					*14.3	*14.3	55'8"
	10	*93.1	*93.1	*72.8	*72.8	*60.5	*60.5	*52.5	*52.5	44.1	*46.9	*26.7	*26.7					*15.3	*15.3	55'4"
	5	*106.5	*106.5	*81.7	*81.7	*66.6	*66.6	53.5	*56.5	42.3	*49.5	*27.0	*27.0					*16.7	*16.7	54'5"
	0 (ground)	113.6	*114.9	84.3	*88.3	85.0	*71.3	51.1	*59.8	40.7	*51.4							*18.7	*18.7	52'11"
	-5	110.0	*118.3	81.1	*92.0	82.5	*74.3	49.4	*61.8	39.6	*52.2							*21.4	*21.4	50'8"
	-10	108.4	*117.4	79.4	*92.6	81.1	*74.9	48.3	*61.8	39.1	*50.8							*25.2	*25.2	47'9"
	-15	108.5	*112.3	79.0	*89.5	80.7	*72.5	48.3	*58.7									*30.7	*30.7	43'9"
-20	*102.2	*102.2	80.0	*81.9	81.8	*65.4	*49.2	*48.2												
-25	*84.9	*84.9	*67.0	*67.0	*48.5	*48.5														

Notes: 1. Ratings are based on SAE J1097.

2. Lifting capacity of the EX Series does not exceed 75% of tipping load with the machine on firm, level ground or 87% of full hydraulic capacity.

3. The load point is a hook (not standard equipment) loaded on the back of the bucket.

4. *Indicates load limited by hydraulic capacity.

Rating over-side or 360 degrees Rating overfront Unit: 1,000 lb

Conditions	Load point height ft	Load radius																At max. reach						
		25 ft		30 ft		35 ft		40 ft		45 ft		50 ft		55 ft		60 ft		ft in	ft in	ft in				
		Side	Front	Side	Front	Side	Front	Side	Front	Side	Front	Side	Front	Side	Front									
Boom 38'9" Arm 13'1" Bucket PCSA: 7.7 cu yd Shoes 31"	40									29.5	29.5							26.7	26.7	55'9"				
	35									29.9	29.9	29.2	29.2					26.1	26.6	58'1"				
	30									30.7	30.7	29.5	29.5					23.3	26.4	59'10"				
	25					42.7	42.7	36.5	36.5	32.5	32.5	30.1	30.1					21.3	26.1	61'0"				
	20							40.1	40.1	34.9	34.9	31.5	31.5	25.9	30.0			19.9	26.1	61'8"				
	15							44.0	44.0	37.5	37.5	31.8	33.1	25.1	30.6			19.2	26.4	61'10"				
	10							45.9	47.5	37.2	40.0	30.1	34.9	24.2	31.6			19.0	27.0	61'7"				
	0 (ground)							41.7	52.4	33.9	43.9	27.7	37.7	22.8	33.1			20.4	29.2	59'5"				
	-10					51.6	64.1	40.6	53.3	32.6	44.8	27.1	36.0					25.0	29.7	55'0"				
	-15			69.7	73.6	52.3	61.9	41.0	51.9	33.2	43.5	28.0	35.9					29.1	29.1	51'9"				
	-20	79.5	79.5	68.7	68.7	53.6	58.2	42.2	48.8	34.5	40.2							27.2	27.2	47'6"				
	-25	71.0	71.0	61.5	61.5	52.0	52.0	42.8	42.8															
-30	58.3	58.3	50.4	50.4	41.3	41.3																		
Boom 38'9" Arm 18'1" Bucket PCSA: 6.5 cu yd Shoes 31"	40																	18.6	18.6	61'2"				
	35												23.4	23.4				17.9	17.9	63'4"				
	30												24.1	24.1	23.6	23.6		17.5	17.5	64'10"				
	25												27.7	27.7	25.4	25.4	24.1	24.1	17.0	17.3	65'11"			
	20					41.2	41.2	34.7	34.7	30.2	30.2	27.1	27.1	25.1	25.1	20.5	24.4	15.9	17.3	66'7"				
	15							38.6	38.6	33.0	33.0	29.0	29.0	25.9	26.3	19.9	24.8	15.2	17.6	66'9"				
	10							42.5	42.5	35.9	35.9	30.8	31.1	24.5	27.8	19.1	25.6	15.0	18.0	66'5"				
	0 (ground)							41.7	48.7	33.8	40.6	27.4	34.7	22.1	30.3	17.8	27.0	15.9	19.7	64'6"				
	-10					49.5	62.7	39.0	51.5	31.4	43.1	25.6	36.6	21.0	31.3			19.1	22.6	60'6"				
	-15			65.2	75.7	49.3	62.1	38.8	51.4	31.2	43.1	25.5	36.3	21.4	30.3			22.0	25.1	57'8"				
	-20	67.9	67.9	66.4	72.6	50.0	60.1	39.2	50.0	31.6	41.8	26.1	34.7					24.5	24.5	54'0"				
	-25	61.2	61.2	67.6	67.6	51.5	56.3	40.4	46.9	32.9	36.6	26.1	29.5					22.7	22.7	49'4"				
-30	71.6	71.6	60.1	60.1	50.1	50.1	40.9	40.9	31.0	31.0														
Boom 38'9" Arm 23'0" Bucket PCSA: 5.6 cu yd Shoes 31"	40																	14.3	14.3	66'0"				
	35																	22.8	22.8	20.2	20.2	14.0	14.0	67'11"
	30																	23.1	23.1	23.1	23.1	13.8	13.8	69'5"
	25														25.3	25.3	24.1	24.1	23.5	23.5	13.9	13.9	70'4"	
	20														27.4	27.4	25.5	25.5	24.3	24.3	14.1	14.1	70'11"	
	15							44.8	44.8	37.9	37.9	33.1	33.1	29.6	29.6	27.2	27.2	25.1	25.4	14.4	14.4	71'1"		
	10							50.9	50.9	42.3	42.3	36.3	36.3	32.0	32.0	28.9	28.9	23.9	26.7	15.0	15.0	70'10"		
	0 (ground)							56.8	61.0	47.8	49.9	39.2	42.2	32.3	36.5	26.6	32.3	21.9	28.1	16.3	16.7	69'0"		
	-10			69.4	82.3	54.2	66.3	43.7	54.7	35.8	46.2	29.7	39.7	24.7	34.7	20.7	30.5	18.5	19.6	65'4"				
	-15	73.0	73.0	69.0	82.3	53.4	67.0	42.6	55.7	35.0	47.1	29.0	40.4	24.3	35.0	20.7	30.2	20.6	21.7	62'9"				
	-20	95.6	99.6	69.3	80.9	53.4	66.5	42.6	55.0	34.8	47.0	28.9	40.2	24.4	34.3			23.6	24.6	59'5"				
	-25	95.2	95.2	70.5	77.8	54.0	64.5	43.0	54.1	35.2	45.7	29.4	38.6	25.5	31.6			27.3	27.3	55'5"				
-30	88.2	88.2	72.4	72.8	55.0	60.7	44.2	50.9	36.4	42.6	30.9	34.5												
-35	78.1	78.1	65.0	65.0	54.2	54.2	44.8	44.8	35.6	35.6														
-40	63.4	63.4	52.8	52.8	43.0	43.0	32.4	32.4																

These specifications are subject to change without notice.

Hitachi Construction Machinery Co., Ltd.

Head Office: Nippon Bldg. 6-2, 2-chome, Ohtemachi,
Chiyoda-ku, Tokyo 100 Japan

Telephone: Tokyo (03) 3245-8361

Facsimile: Tokyo (03) 3246-2606

Telex: J32539 HITACONJ

Cable Address: "TOKHITACHIKENKI"