

HITACHI

EH 1000

Maximum Payload
59,9 Tonne (66.0 Ton)

**Maximum Payload
with Standard Liners**
56,9 Tonne (62.8 Ton)

Maximum GMW
101 605 kg (224,000 lb)

Engine
Cummins QSK19-C700
Rated Output 522 kW (700 hp)



Specifications: EH1000



ENGINE

Make	Cummins			
Model	QSK19-C700			
Type	4 Cycle			
Aspiration	Turbocharged/Aftercooled			
Rated Output (SAE @ 2100 rpm)	kW	hp	522	700
Flywheel Output (SAE @ 2100 rpm)	kW	hp	483	648
No. Cylinders	6			
Bore & Stroke	mm	159 x 159		
	in	6 1/4 x 6 1/4		
Displacement	liters	in ³	18,8	1,150
Maximum Torque @ 1200 rpm	N•m	lb/ft	3 084	2,275
Torque Rise	26%			
Starting	Electric			



TRANSMISSION

Allison M6600, remote-mounted, planetary type, with integral torque converter features automatic lockup in all ranges for improved fuel economy. Allison Commercial Electronic Control provides shift logic as well as park brake interlock, hoist interlock and built in diagnostics. Trim Boost Soft Shift provides smooth shifting to help reduce operator fatigue. Six fully automatic forward speeds and two selectable reverse speeds allows the operator more flexibility in any application. Air to oil transmission cooler eliminates potential transmission contamination.

Maximum Speeds Governed Engine Speed with standard 24.00R35(**) E4 tires

Range	Gear Ratio	Standard 3.73:1 Differential		Optional 3.15:1 Differential	
		km/h	mph	km/h	mph
1	4.00	10,2	6.3	12,1	7.5
2	2.68	15,2	9.4	17,9	11.1
3	2.01	20,2	12.6	24,0	14.9
4	1.35	30,1	18.7	35,6	22.1
5	1.00	40,6	25.3	48,3	30.0
6	0.67	61,3	38.1	72,6	45.1
R1	5.12	8,0	5.0	9,5	5.9
R2	3.46	11,9	7.4	14,2	8.8



DRIVE AXLE

Full floating axle shafts, Euclid Model 2354 differential and single reduction planetary at each wheel. Balanced life gear design maximizes gear life.

Ratios	Standard	Optional
Differential	3.73:1	3.15:1
Planetary	5.80:1	5.80:1
Total Reduction	21.63:1	18.27:1
Maximum Speeds with 24.00R35 Tires	km/h 61,3 mph 38.1	km/h 72,6 mph 45.1



TIRES

Standard - Front and Rear	Rim Width
24.00-R35 Radial	mm in 432 17
Optional tires, brands and treads available.	



ELECTRICAL SYSTEM

Twenty-four volt lighting and accessories system. 75 amp alternator with integral transistorized voltage regulator. Two 900 amps, cold cranking, 12-volt, maintenance-free, heavy-duty batteries connected in series.

Standard CONTRONIC II monitoring and central warning system with built-in diagnostics. Standard Liquid Crystal Display.



BODY CAPACITY

	m ³	yd ³
Struck (SAE)	25	33
Heap 3:1	32	42
Heap 2:1 (SAE)	36	47



WEIGHTS

	kg	lb
Chassis with Hoist	30 969	68,275
Body	10 761	23,725
Net Machine Weight	41 730	92,000

Maximum GMW with Std. Tires [24.00R35(**)E4] Including Options, 50% Fuel, Operator & Payload Not to Exceed 101 605 224,000

Maximum Payload 59 875 132,000

*Major Options
Approximate change in Net Machine Weight:
Light Duty Body Liners - 400 BHN Steel 2 948 6,500
Heavy Duty Body Liners - 400 BHN Steel 3 719 8,200

Max. Payload with Light Duty Body Liners 56 927 125,500

Weight Distribution	FRONT	REAR
Empty	48%	52%
Loaded	33%	67%



STEERING SYSTEM

Closed-center, full-time hydrostatic power steering system using two double-acting cylinders, pressure limit w/unload piston pump and brake actuation/steering system reservoir. Accumulator provides supplementary steering in accordance with SAE J/ISO 5010. Tilt/telescopic steering wheel with 35° of tilt and 57,15 mm 2.25" telescopic travel.

Steering Angle	39°			
Turning Diameter (SAE)	m	ft in	19,28	63'3"
Steering Pump Output (@ 2100 rpm)	l/m	gpm	95,7	25.3
System Pressure	kPa	psi	18 961	2,750



HYDRAULIC SYSTEM

Two (2) Euclid two-stage cylinders, double-acting in second stage, internal cushion (extend and retract), inverted and outboard mounted. Separate Hoist/Brake Cooling reservoir and independent tandem gear pump. Electronic control valve mounted on reservoir. Hoist lever mounted on left of seat. Equipped with body up speed restriction and reverse inhibit while hoisting.

Body Raise Time	s	10.0		
Body Float Down Time	s	14.0		
Body Power Down Time	s	11.0		
Brake Cooling Pump Output	l/m	gpm	176	47
Hoist Pump Output	l/m	gpm	468	123
System Relief Pressure	kPa	psi	17 237	2,500



BRAKE SYSTEM

Brake system complies with SAE J/ISO 3450.

All-hydraulic actuated braking system providing precise braking control and quick system response. The Euclid brake controller has a unique variable front to rear brake proportioning that maximizes the stopping performance under all road conditions.

Service

All-hydraulic actuated front disc brakes and rear oil-cooled wet disc.

Front Axle - Dry Disc

Disc Diameter Each (2 discs/axle)	cm	in	68,6	27
Brake Surface Area Per Axle	cm ²	in ²	4 129	640
Lining Area Per Axle	cm ²	in ²	2 787	432
Brake Pressure (Max.)	kPa	psi	15 859	2,300

Rear Axle - Oil-Cooled Wet Discs

Brake Surface Area Per Axle	cm ²	in ²	59 616	9,240
Brake Pressure (Max.)	kPa	psi	4 482	700

Secondary

Two independent circuits within the service brake system provide back-up stopping capability. System is manually or automatically applied to stop machine within prescribed braking distance.

Parking

Dry disc mounted on differential input shaft. Controlled by a toggle switch on the dash. Automatically applied if brake hydraulic pressure is lost.

Size	mm	in	558	22" dia.
-------------	----	----	-----	----------

Retarder

Foot-operated valve controls all-hydraulic actuation of oil-cooled wet disc brakes on rear axle. System provides modulated pressure to rear brakes for constant speed control.

Continuous	kW	hp	597	800
Intermittent	kW	hp	1 208	1,620



WET DISC BRAKE

The Euclid wet disc brake is engineered for long service life even in the most extreme environments. The wet disc brakes are located on the rear axle and provide service braking, secondary braking, and retarding. The brakes are a multi-plate design, and continuously oil-cooled. The sealed design protects against environmental contamination for prolonged service life. The wet disc brake is designed with automatic retraction to prevent drag. Separate pedals activate the service braking and retarding functions.

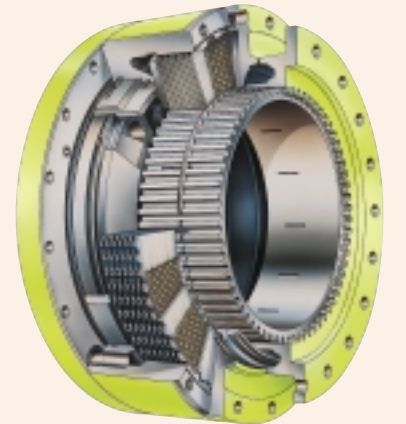

COMMAND CAB III

Command Cab III integral ROPS/FOPS (Rollover Protection Structure) is standard in accordance with SAE J/ISO 3471. Dimensions comply with SAE J/ISO 3411. Double wall construction of 11 gauge inner and outer steel panels, lends itself to a more structurally sound cab. Foam rubber lining material along with foam rubber-backed carpeting and multiple layered floor mat act to absorb sound and control interior temperature. A properly maintained cab from Euclid, tested with doors and windows closed per work cycle procedures in SAE J1166, results in an operator sound exposure Leq (Equivalent Sound Level) of 79 dB(A). A three-point rubber iso-mount arrangement to the deck surface minimizes vibration to the operator compartment.

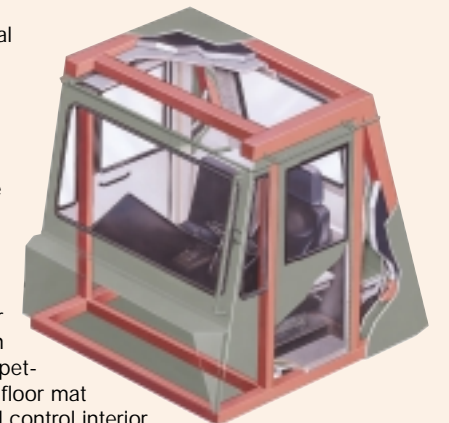

Excellent Serviceability. A removable front panel allows easy access to service brake valves, retarder valve and heater assembly. The upper dash utilizes four (4) removable panels that house gauges and customer options, each individually accessible. A removable panel located behind the seat provides easy access to the shifting control, CONTRONIC II, and all electrical junction points.

Comfort and Ease of Operation. A wrap-around style dashboard positions controls within easy reach and visual contact. A full complement of easy-to-read gauges, CONTRONIC II monitoring and warning system with Liquid Crystal Display (LCD), a spacious environment, six-way adjustable mechanical seat, tilt/ telescopic steering wheel, filtered ventilation, door locks, and a padded trainer seat, all contribute to operator convenience and comfort.



SUSPENSION

Front and Rear Suspension

For years, Euclid haulers have enjoyed an industry-wide reputation for superior suspension systems. That experience and knowledge has now been pushed to the next level, to develop the truly advanced ACCU-TRAC suspension for the EH1000. To make sure it was fine tuned to the limit, Lotus Engineering, a world leader in suspension design, was contracted to review the entire system to assure optimized ride and handling performance.

The new ACCU-TRAC suspension system features independent trailing arms for each front wheel with NEOCON struts, containing energy absorbing gas and compressible NEOCON-E™ fluid, mounted between the king pins and the frame. This arrangement allows a wider front track that provides a better ride, improved stability and a reduced turning circle. The rear axle housing has an A-frame mounting. The rear NEOCON struts are mounted in a more vertical position which allows a more pure axial loading and reduces the tractive and braking forces transmitted to the nose cone.

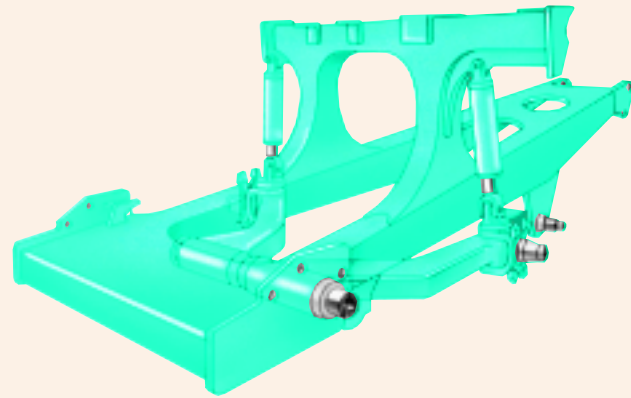

NEOCON struts outperform competitive strut designs by improving isolation, stability, and control. Improved isolation means reduced impact loading on the structural members of the machine and greater operator comfort, resulting in longer equipment life and increased productivity. Improved stability means more consistent dynamic response of the machine to fluctuating load energy, resulting in predictable machine performance. And improved control means better machine maneuverability.

The Euclid frame and ACCU-TRAC suspension system are designed to work in unison to provide maximum structural integrity and operator comfort. The fabricated rectangular frame rail construction provides superior resistance to bending and torsional loads while eliminating unnecessary weight. The unique ACCU-TRAC independent trailing arm suspension absorbs haul road input, minimizing suspension-induced frame twisting while providing independent tire action. NEOCON ride struts are mounted with spherical bushings, eliminating extreme sidewall forces by ensuring a purely axial input to the ride strut. The wide track stance of the ACCU-TRAC suspension system and the long wheel base assure a more stable, comfortable ride.



FRAME

Full fabricated box section main rails with section height tapered from rear to front. Wider at the rear to support the loads and narrower at the front to allow for engine accessibility. One piece top and bottom flanges that eliminate cross member tie in joints and provide a large exposed center area for access to major components. Large radii at frame junctions are blended and ground to minimize stress concentrations. Weld joints are oriented longitudinally to the principal flow of stress for greater durability and more strength. Frame utilizes 345 MPa **50,000 psi** yield high strength low alloy steel that is robotically welded to ensure consistently high quality welds.



BODY

Flat chute type, sloped floor, continuously exhaust heated. High tensile strength 400 BHN abrasion-resistant alloy steel is used in thickness of:

	mm	in
Floor	18	11/16
Front	10	3/8
Sides	8	5/16
Canopy	6	1/4
Optional Body Liners (Light Duty)		
Floor & Top Rails	10	3/8
Sides & Front	6	1/4
Optional Body Liners (Heavy Duty)		
Floor	13	1/2
Sides & Front	8	5/16
Sides & Front	10	3/8

The horizontal stiffener design of the Euclid body minimizes stress concentrations in any one area. Load shocks are dissipated over the entire body length. The closely spaced floor stiffeners provide additional protection by minimizing distance between unsupported areas.

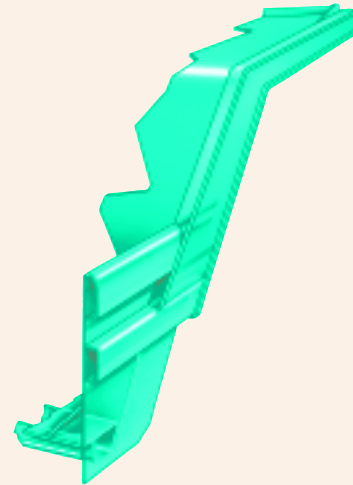

SERVICE CAPACITIES

	liters	gallons
Crankcase (incl. filters)	60,6	16.0
Transmission (incl. filters)	87,0	23.0
Cooling System	189,3	50.0
Fuel Tank	700,2	185.0
Hydraulic		
Hoist Tank	174,1	46.0
Steering Tank	98,4	26.0
Drive Axle	118,8	31.4
Windshield Washers	5,7	1.5

STANDARD EQUIPMENT

GENERAL

ACCU-TRAC suspension system
Air conditioning
Air to oil transmission cooler
Allison M6600 transmission
All hydraulic braking
Automatic transmission shifting
Battery disconnect switch
Body down indicator, mechanical
Body up and down cushioning
Body up speed restriction
Body prop cable
Bolt-on nose cone bushing
Canopy spill guard
Continuous heated body
Cooling system sight gauge
Cooling system surge tank
Dagger clamps (rear wheels)
Electric horns
Electric start
Electronic hoist
Engine belt protection
Fan guard
Fenders
Fixed steering stops
Front brake cut off
Driveline guard, front

CAB

Acoustical lining
Air filtration/replaceable element
Ash tray
Cab interior light
Cigar lighter, 12 volt
Door locks
Foot rest (left and right)
Full trainer seat
Heater and defroster 26,000 Btu
Integral ROPS/FOPS cab
ISO driver envelope
Liquid Crystal Display* (CONTRONIC) II
 Boost pressure
 Clutch pressure
 Distance traveled
 Engine oil pressure
 Fuel gauge
 Fuel pressure
 Gear selection
 Injector timing rail-pressure
 Intake manifold temperature
 Integrated engine diagnostics

GAUGES AND INDICATORS

CONTRONIC II monitoring and alarm system, multi-function indicator lights:
Air filter restriction
Alternator
Body up
Brake system low pressure
Central warning
Converter temperature
Coolant level
Cooling temperature
Engine oil pressure
Engine service
Engine shut down
High beam indicator
Hydraulic filter
Park brake applied
Retard oil temperature
Steering filter
Steering pressure
Steering temperature
Transmission oil pressure
Transmission filter
Transmission malfunction
Turn signals/hazard
Do not shift
Transmission malfunction

MACHINE LIGHTS

Back-up light (2)
Clearance lights (2)
High intensity head lights (HID) (4)

Stop & tail (2)
Turn signals and four-way flashers

Guard rails
HID headlights
Hoist interlock
Hoist tank sight gauge
ISO decals
LED tail lights
Load/dump brake
Mirrors right and left, hand adjustable
Mud flaps
NEOCON suspension struts
Park brake, dry disc
Park brake interlock
Radiator grill guard
Radiator, premium core
Reverse alarm
Rock ejector bars
Steering accumulator
Steering tank sight gauge
Swing-out grille
Tires, 24.00R35
Tire guards, bolt-on
Tow points front/rear
Transmission guard
Transmission sight gauge
Two-speed reverse

Integrated transmission diagnostics
Load counter
Service intervals, job site adjustable
Throttle position
Total engine hours
Total idle hours
Voltmeter
Mechanical, 6 position seat
Modular instrumentation
Quick connect test ports
Roll down windows
Rubber floor mat
Safety glass
Seat belts retractable (operator/trainer)
Sun visor
Tilt/telescopic steering wheel
Tinted glass all windows
12 volt 50 amp circuit
12 volt accessory connection
Windshield washer
Windshield wiper, intermittent

Gauges:

Brake temperature
Converter temperature
Coolant temperature
Hourmeter (LCD)
Speedometer
Steering/brake pressure
Tachometer

OPTIONAL EQUIPMENT

Air suspension seat
ACTIVE TRACTION CONTROL (ATC) w/ELECTRONIC DOWNHILL SPEED CONTROL (EDSC)
Body liners (400 BHN) plates light or heavy duty
Body sideboard extensions
Canopy spill guard extension
Cold start aid
Differential, 3.15:1 ratio
Driveline guard, rear
Engine compartment lights
Engine compartment step

Engine heater (oil & coolant)
Extra reverse alarm
Fast fueling, fuel only
HAULTRONIC II-load monitoring system
Hoodsides
Kim hotstart pre-heaters
Lube system, automatic
Lube system, centralized
Muffler, deck mounted
Radio & tape player
Starter lock-out switch
Tires (size, type & rating)
Unit sound suppression

Standard and optional equipment may vary from country to country. Special options provided on request. All specifications are subject to change without notice.

Note: Dimensions shown are for empty machine with 24.00R35(**) E4

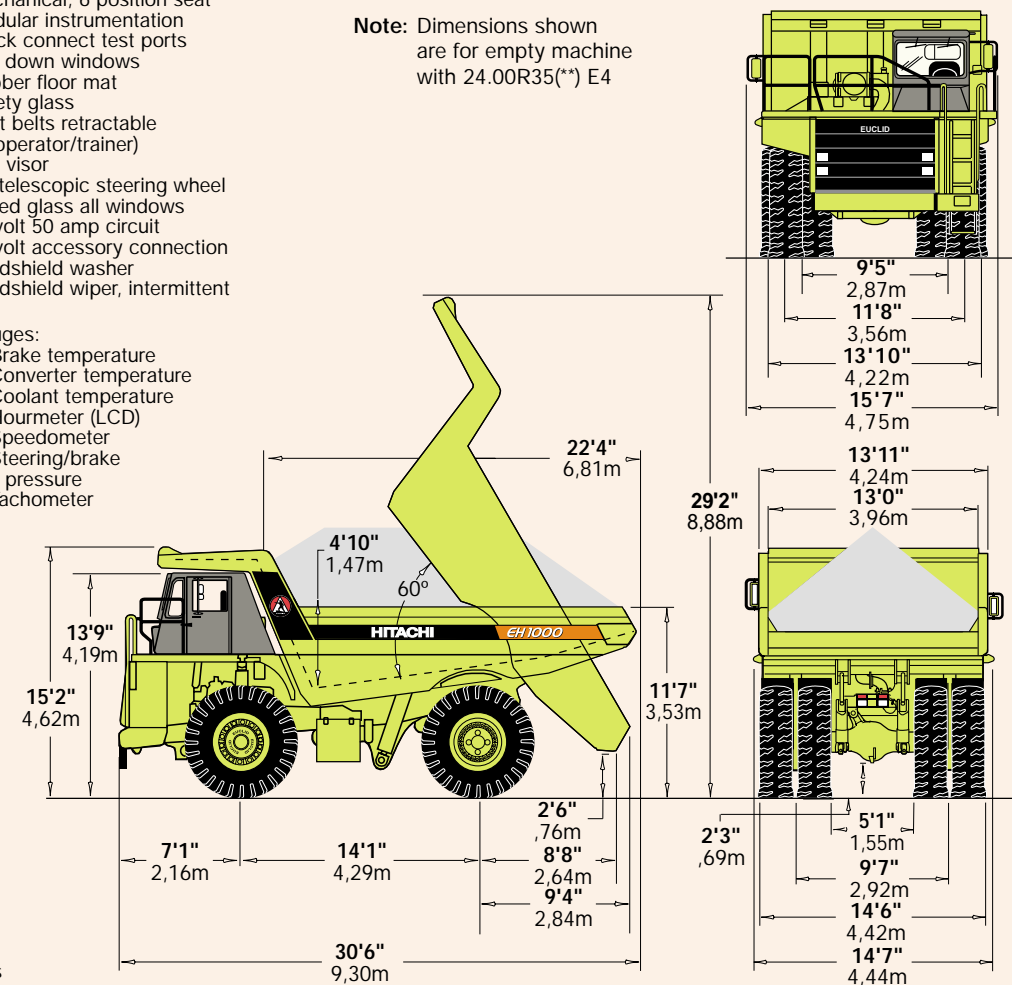

Performance Data: EH1000

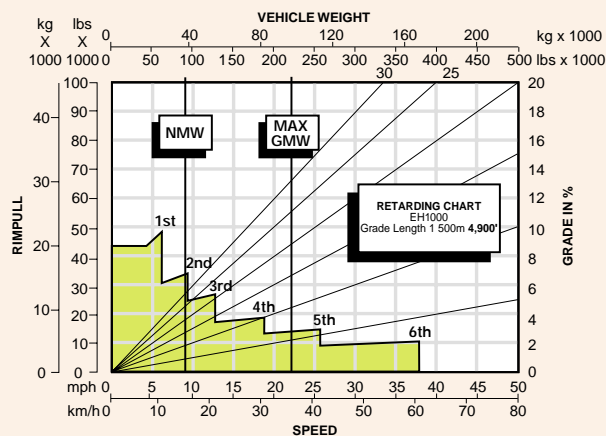
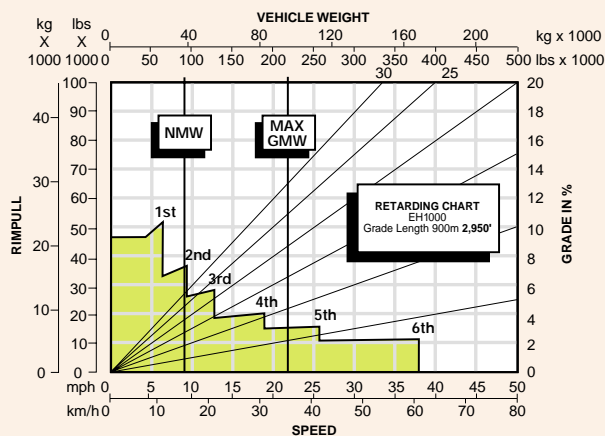
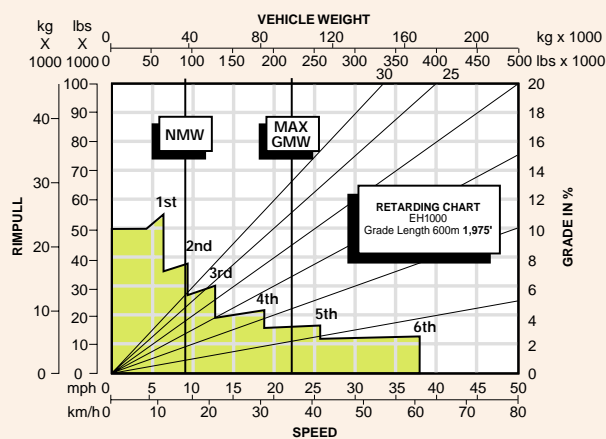
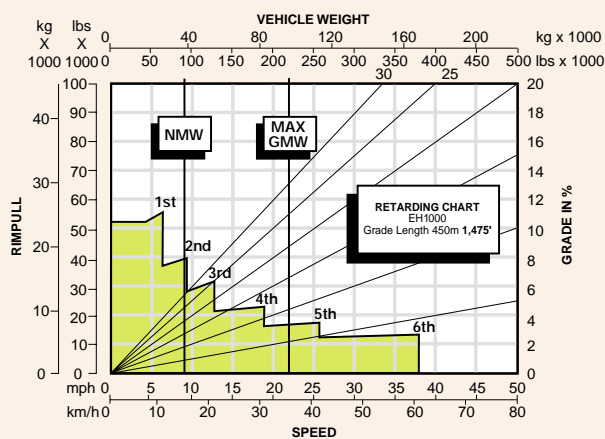
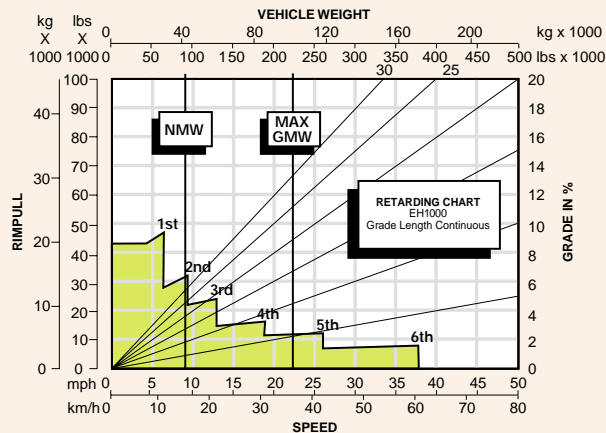
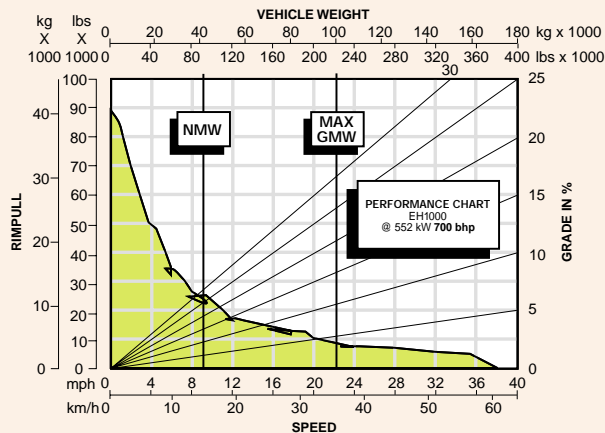

INSTRUCTIONS:

Diagonal lines represent total resistance (Grade % plus rolling resistance %). Charts based on 0% rolling resistance, standard tires and gearing unless otherwise stated.

1. Find the total resistance on diagonal lines on right-hand border of performance or retarder chart.
2. Follow the diagonal line downward and intersect the NMW or GMW weight line.
3. From intersection, read horizontally right or left to intersect the performance or retarder curve.
4. Read down for machine speed.

NOTE: Photos and illustrations throughout may show optional equipment.

Under our policy of continuous product improvement, we reserve the right to change specifications and design without prior notice. The illustrations do not necessarily show the standard version of the machine.

Hitachi Construction Machinery (America) Corp.
20411 Imperial Valley Dr.
Houston, Texas 77073
281-821-2400
www.hcmacorp.com



FORM NO. EH1000
DATE 6/01
Printed in U.S.A.